

# WYNDHAM COLLECTION

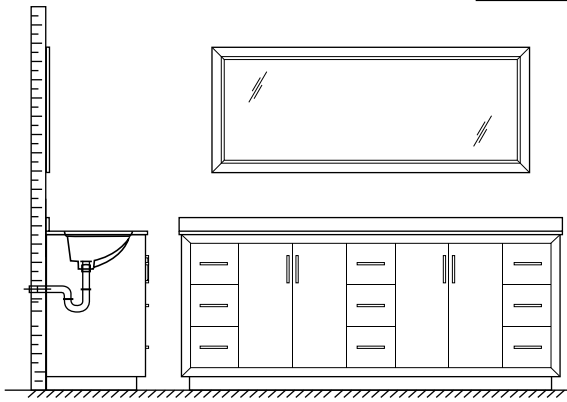

- Prior to installation please check received items against the "Packing List". Please report any missing items to your retailer immediately.
- Protect all surfaces from sharp objects, high heat sources, direct prolonged sunlight and chemical hazards.
- Professional installation recommended.
- Please install on a level surface. If minor door and drawer alignment is required, please follow the easy directions below.
- Backsplash comes in two pieces.

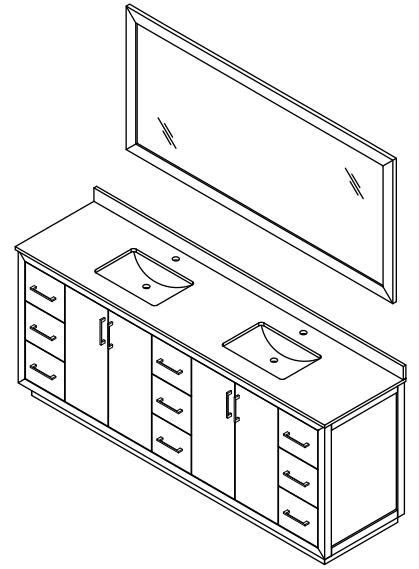

## PACKING LIST

(Not all components may be included, depending upon your purchase)

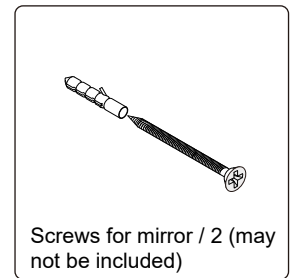
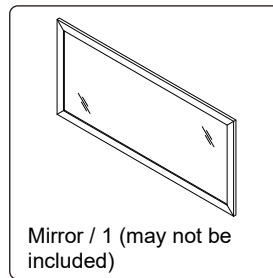
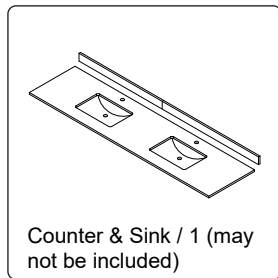
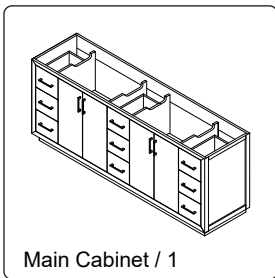

## HOW TO ADJUST HINGES (if required)

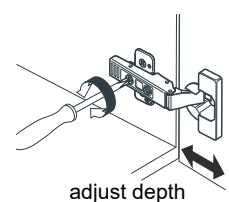
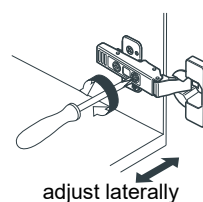
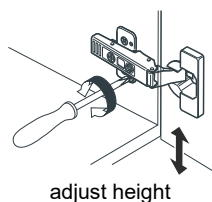
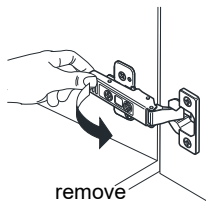
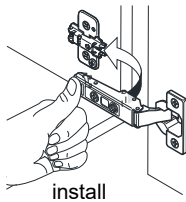

## REQUIRED TOOLS NOT IN BOX

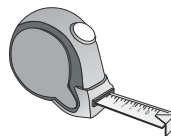
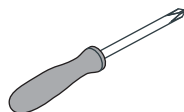
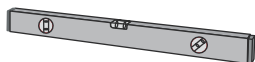

# WC-4141-84-DBL Installation Guide

# WYNDHAM COLLECTION

## INSTALLATION INSTRUCTIONS

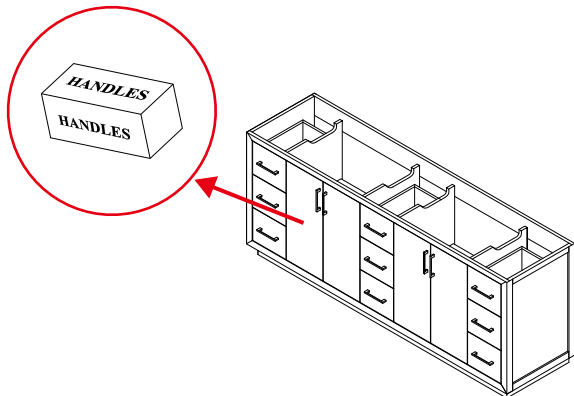

- ① The handles are safely stored for transport in a box inside of the cabinet. Look inside the vanity for the box with your handles.

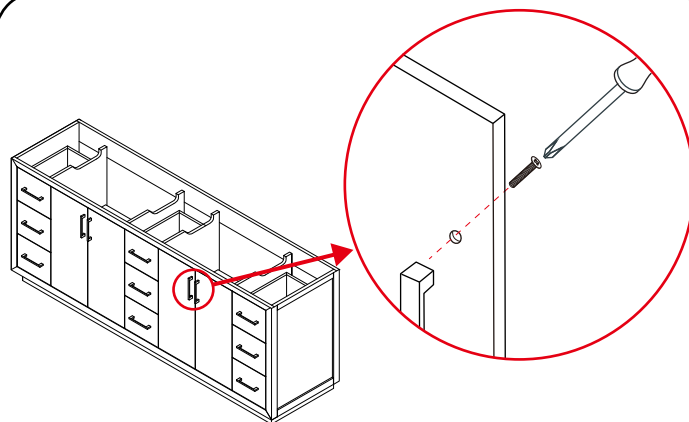

- ② Unpack the handles and install them on the vanity. Do not over tighten when attaching.

Short, for door handles

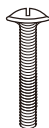

Long, for drawer handles

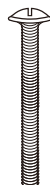

- ③ Short screws are for the door handles and long screws are for the drawer handles.

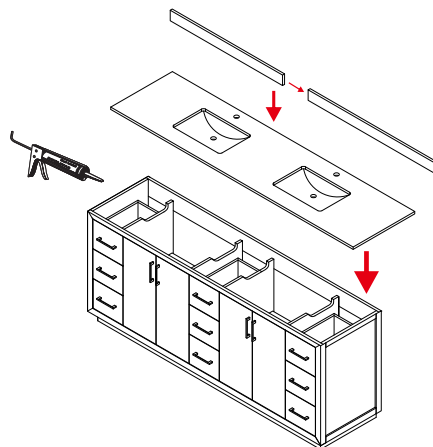

- ④ Install the counter. Seal around the top of the cabinet with clear silicone sealant. Do not over apply. Allow to dry 24 hours for proper curing.

WC-4141-84-DBL  
Installation Guide

# WYNDHAM COLLECTION

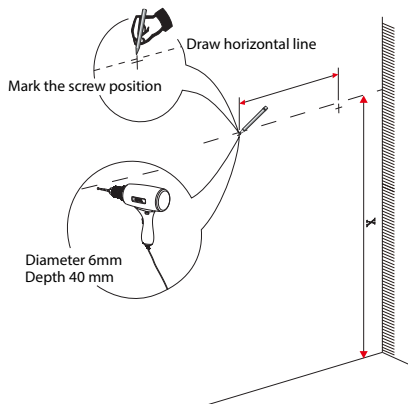

- ⑤ Install the mirror: use a pencil to mark the placement of the screw holes on the wall, drill the holes and insert the plastic wall anchors.

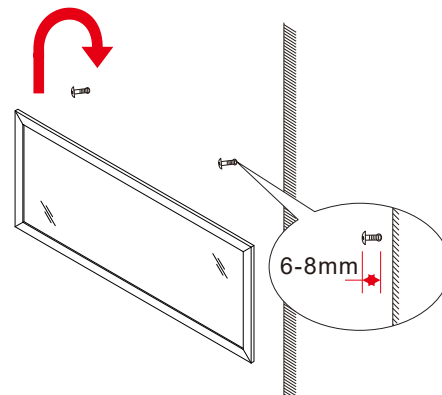

- ⑥ Install the screws into the wall anchors, leaving enough of the screw exposed to hang the mirror - approx 1/4" - 1/2".

## HOW TO ADJUST DRAWER SLIDES (if required)

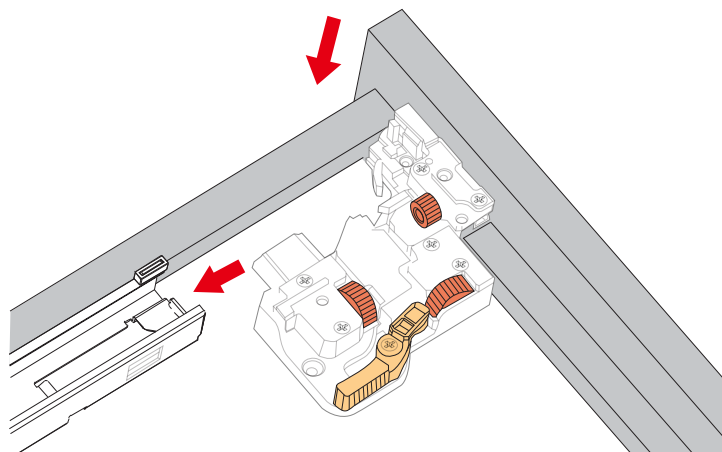

Up and Down Adjustment

WC-4141-84-DBL  
Installation Guide

# WYNDHAM COLLECTION

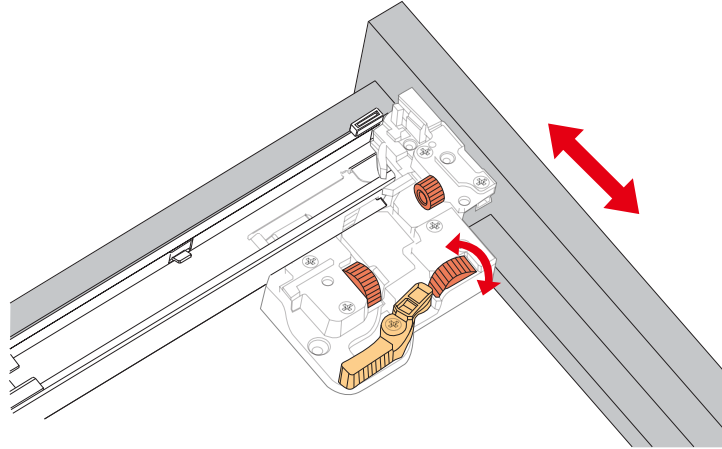

Side Adjustment

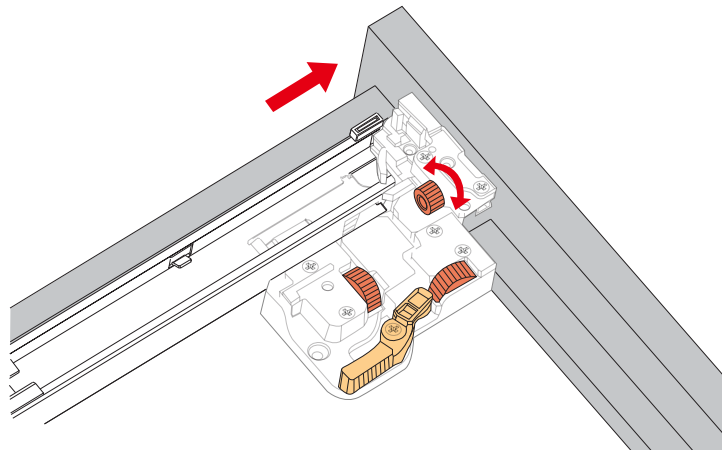

Depth Adjustment



Scan the QR code with your phone to watch detailed video instructions or visit [www.wyndhamcollection.com/3dslides](http://www.wyndhamcollection.com/3dslides)

WC-4141-84-DBL  
Installation Guide

# WYNDHAM COLLECTION

## Backboard Cutouts

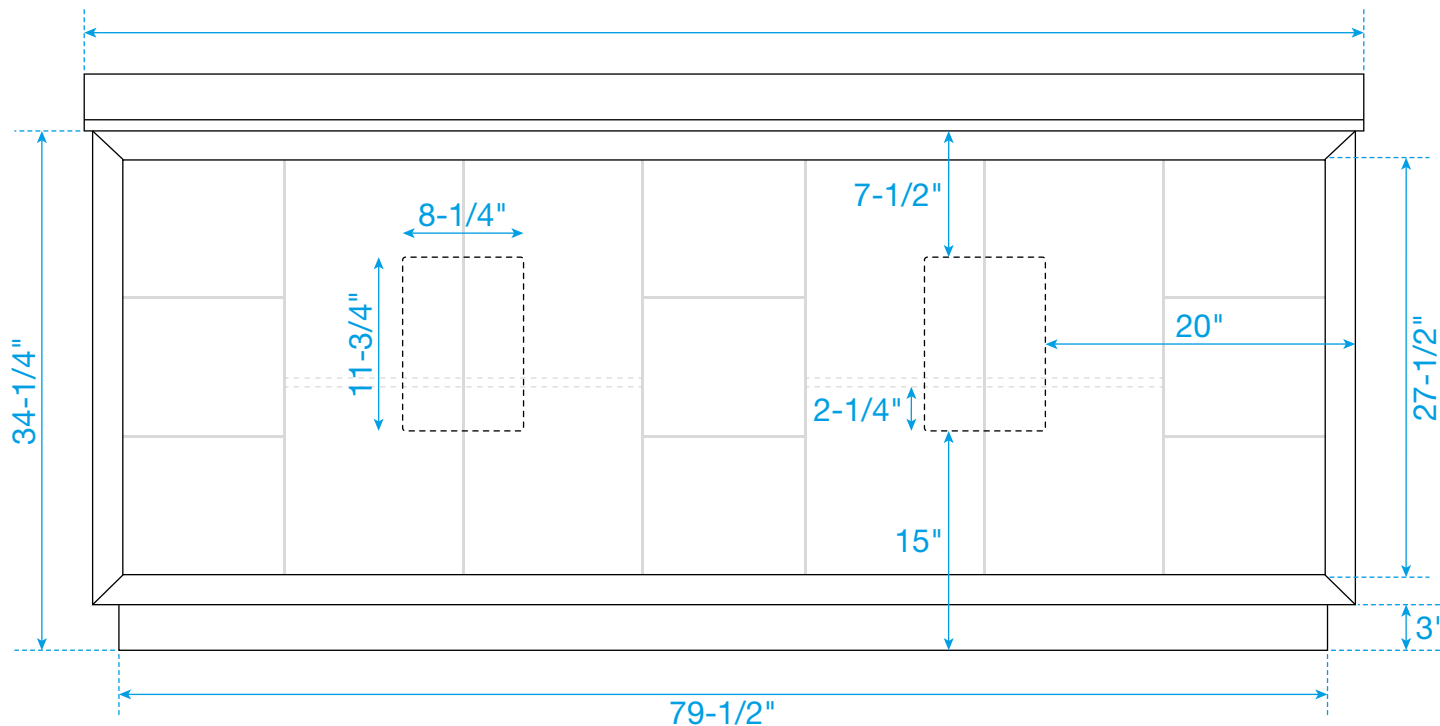

\*Note: All measurements are  $\pm 1/4"$ .

## Electrical Outlets with Charging Hub

- Easy to install
- Long 5 foot plug in cord
- 2 electrical outlets, 125V 15A
- Tamper Resistant (TR) outlets
- Power reset switch
- 2 USB ports, 5V 2.1A Max
- Use with ground-fault circuit interrupter (GFCI) outlets only
- Residential use only
- Follow all applicable electrical codes
- ETL Listed
- Conforms to UL Standard 962A
- Certified to CAN/CSA Standard C22.2 No. 308

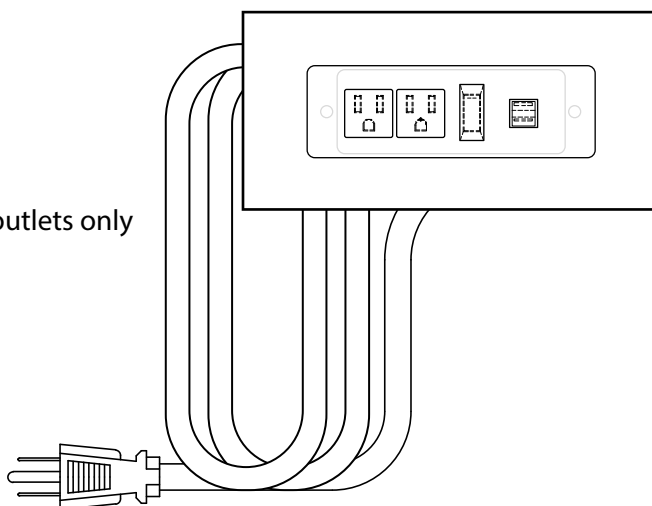

# WC-4141-84-DBL Installation Guide